

# KNOWLEDGE Net

*Bringing you Knowledge at your Fingertips*

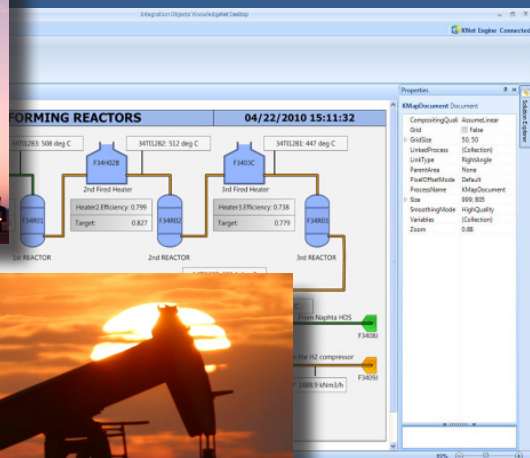
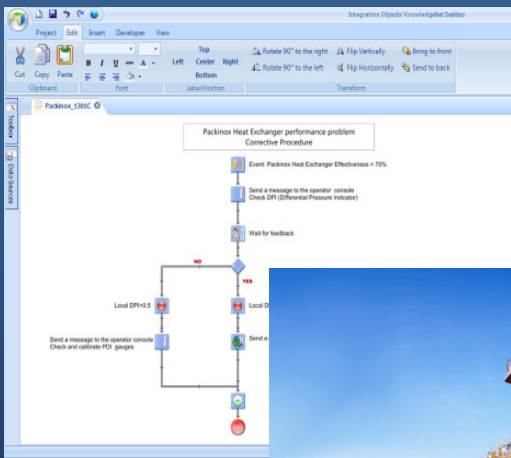

## Integration Objects' KnowledgeNet: Empowering you for Reaching operational excellence

### Abnormal Events Detection

KNet allows you to monitor and manage plant operations and supply chain performance. It empowers its users to make effective business and operation decisions by gathering the right data, information and knowledge scattered across many islands of automation such as distributed control systems (DCS), supervisory controls and data acquisition (SCADA), data validation and reconciliation applications, laboratory information management systems, plant data historians, and enterprise resource planning (ERP).

### Empowering Operations with Knowledge

KNet acts as your operations expert by building up knowledge in the system and **providing guidance for the operators**. It can quickly identify opportunities for operational improvements and root causes of problems when they arise and swiftly guide plant operators in making the most effective decisions.

### Performance Deviations Management

KNet enables you to employ innovative KPI expert functions to monitor and manage plant-wide performance, improve plant safety, and identify areas for profitability improvement. It uses **root cause analysis** to automatically detect any KPI deviations and advises you about their impacts and the proper corrective actions to be taken. From equipment performance and day-to-day operations to long-term strategic goals, KNet helps you to manage your performance and optimize your operations.

### Diagnostic & Operation Guidance

KNet transforms real-time data, information, and knowledge into graphical views, thus simplifying and improving visibility at every level of the business hierarchy and **generating a global view of the enterprise**. KNet offers a graphical framework that makes applications, such as enterprise asset management and operational performance reporting, easy to integrate.

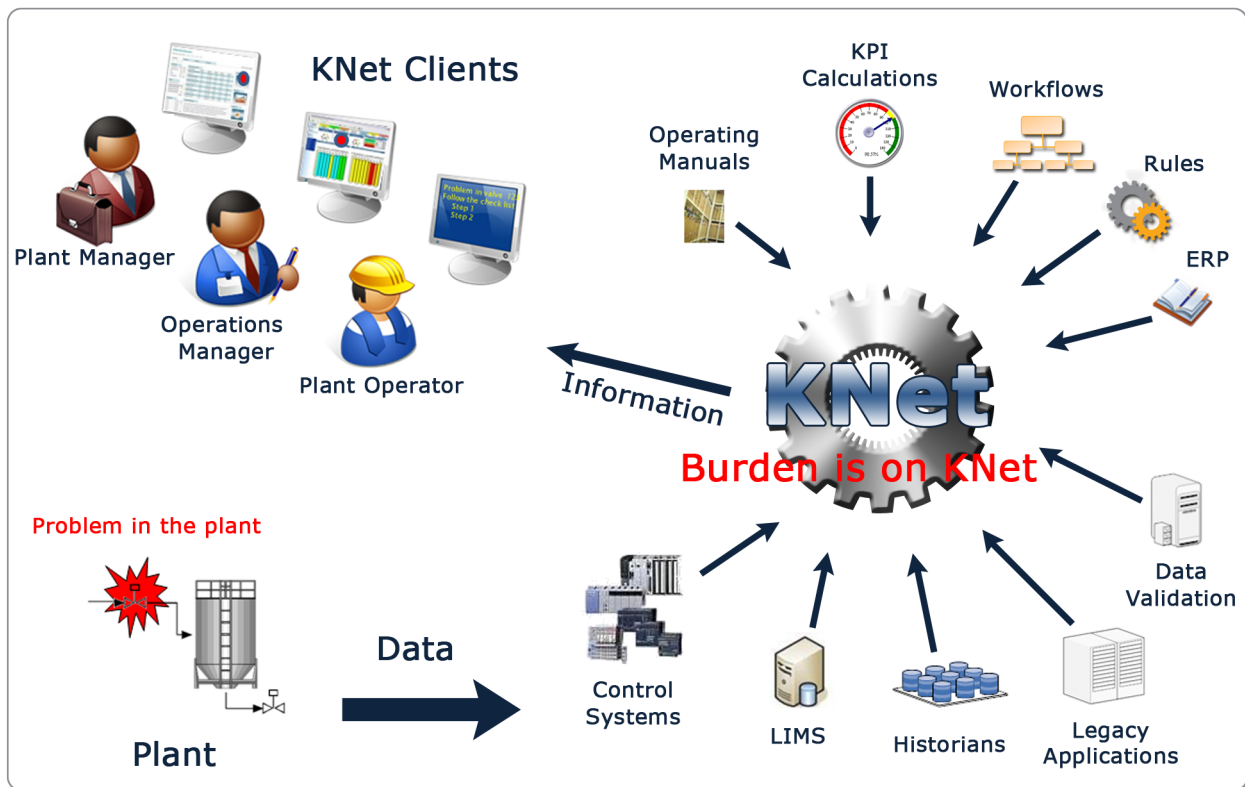

**KNet Approach:** Helping operations to focus on key issues, as well as maximize asset availability and safety. KNet takes away from operators the burden of gathering, analyzing, and reasoning over data and information from control systems, databases, plant applications, and operation procedures. It also shortens the decision making process in order to prevent further performance deviation and safety issues, with the objective of maximizing plant efficiency.

# Features

## Operational & Manufacturing Intelligence

Plant managers, shift supervisors and operators can benefit from the knowledge built into KNet in order to improve the execution of operation procedures, organization of team work, process supervision and early detection of critical situations. To do so, a smart engine is embedded in the KNet platform allowing you to:

### Detect problems' root causes using intuitive Fault Propagation Models

- Detect faults and symptoms by executing Event Detection Diagrams
- A toolbox of plant and process objects to drag, drop, and connect from
- Automatically identify root causes, thereby reducing the resolution time
- Support operators in their daily activities and decisions

### Define and execute workflows

- Graphically create, update, delete, and execute static and generic workflows
- Customize the workflow blocks through integrated C# procedures
- Reduce modifications and migration development efforts through the use of generic workflows
- Deploy your best practices online

### Execute graphically defined rules

- Graphically define and execute data flow models as well as process and business rules
- Benefit from real-time multithreaded data processing capability
- Customize your rules through C# .NET procedures

## Profitability Improvement

KNet significantly reduces the cycle time from when the issue is detected to when it is resolved, whether the issue lies at the maintenance, operations, or business levels of the enterprise. It readily retrieves operational knowledge spread across the enterprise while employing Key Performance Indicators to pin-point opportunities in order to improve your operations and increase profitability.

## The Ultimate in Customization and Extensibility

Toolkits are provided for developing custom plug-ins to integrate other systems and to develop customized thick and web-based client applications. Users can also create their own graphical blocks and objects in KNet Desktop by using Class Wizard and C# .NET Editor.

## Interactive Integrated Development Environment (IDE)

With a graphical development environment (KNet Desktop), application developers can configure applications to proactively monitor the enterprise's performance and process conditions, perform root cause analysis, execute and supervise business workflows, and state transition diagrams. Engineers have access to a library of graphical objects they can drag, drop, and connect in project workspaces.

Engineers can also benefit from a rich test environment, facilitating the debug and troubleshooting activities through a multiple messages and event browsers.

## Data, Information and Knowledge Collection

KNet collects and aggregates data, events, information, and knowledge from multiple sources for supervision, plant performance management, and decision support applications. KNet integrates multiple applications and systems using industry standards such as OPC, ADO .NET, SOA, and WCF, while custom applications can be added as data sources using KNet plug-ins.

## Security and User Authentication

Using KNet allows you to:

- Define access privileges and user accounts according to predefined security policies
- Track client/server communications
- Limit the number of open ports within your firewalls.

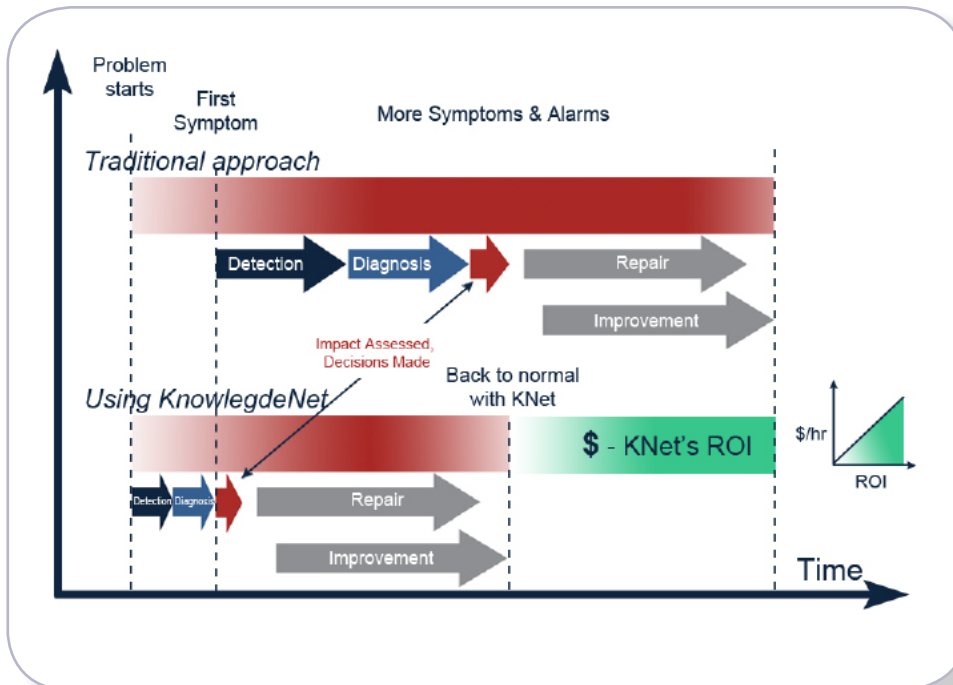

### KnowledgeNet for Profit Improvement

Using Fault Propagation Models to find root causes, KnowledgeNet detects problems before the first symptoms present themselves. This faster reaction time allows the user to quickly diagnose and tend to the problem much earlier, saving time, money, and other valuable resources.

# KRules: Complex Events Detection

## KRules Goals

- 1 Early detection of abnormal conditions
- 2 Transform raw data into information and knowledge
- 3 Implement what-if and simulation scenarios
- 4 Easily and rapidly develop your real-time operations logic

KRules module allows users to build applications such as business rules, performance management applications to calculate KPIs, applications executing data transfer between different systems, predictive maintenance applications, prototyping, modeling, and simulation applications.

Along with detecting problems, faults, and abnormal conditions through real-time event detection

diagrams, this module can also make predictions using symptoms detection and statistical techniques.

To do so, KRules offers you a wide range of blocks including arithmetic, statistical process controls, signal generators, data filters, logic gates, temporal data blocks, and more. Application developers can also add their own custom blocks using the C# .NET language.

KRules transforms data into information using knowledge modeling and uses event detection to automatically detect problems, faults, or abnormal conditions. Operations can quickly assess any event in real time in order to take corrective actions and can calculate key performance indicators to tie your business objectives directly to your operations.

### Feed Pump Cavitation Due to High Water in Feed During Startup

(Erratic feed Flow due to cavitation 34FC12PV-SP standard deviation in 10 minutes updated every 1 minute > 4.05)  
OR  
(3412A.PV standard deviation in 10 minutes updated every 1 minute < 8% of recent daily average)  
OR  
(3412B.PV standard deviation in 10 minutes updated every 1 minute < 8% of recent daily average)

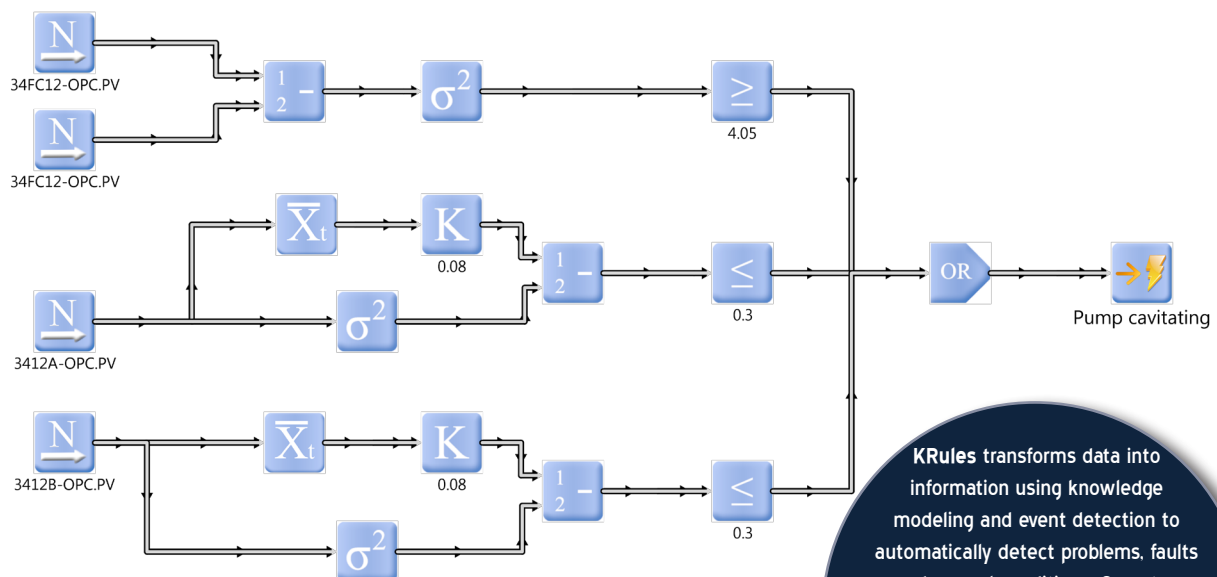

KRules Example: Pump Cavitating Fault Detection Diagram

KRules transforms data into information using knowledge modeling and event detection to automatically detect problems, faults or abnormal conditions. Operators can quickly assess what is happening in real time in order to take corrective actions, and calculate key performance indicators to tie your business objectives directly to your operations.

# KRCA: Diagnostics and Decision Support

KNet Root Cause Analysis module (KRCA) allows application developers to implement decision support systems, graphical diagnosis applications, and abnormal condition management systems. Using fault propagation models, KRCA diagnoses faults in real time, isolates root causes, advises about response plans, and executes corrective procedures.

Built graphically with the KNet Desktop, these fault trees employ cause and effect knowledge. Tests and corrective actions can be simple messages, complex rules or entire workflows.

## KRCA Goals

- 1 Capture many years of operational knowledge
- 2 Identify root causes of operational issues
- 3 Reduce the time of resolution cycles
- 4 Empower operators with knowledge at their fingertips

Faults detected by KRCA can include problems related to efficiency, equipment failure, environmental regulations, unsafe conditions, and KPI deviations. Such abnormal conditions can have many serious consequences including: unplanned downtime, broken schedules, safety hazards, poor quality, inefficient operation, and more.

KRCA diagnosis is triggered by any detected fault. It checks additional problems, runs tests to determine root causes, and notifies operators if they must take any corrective actions and/or start workflows for resolution procedures execution.

### Root Cause Analysis for Regeneration Time too Long

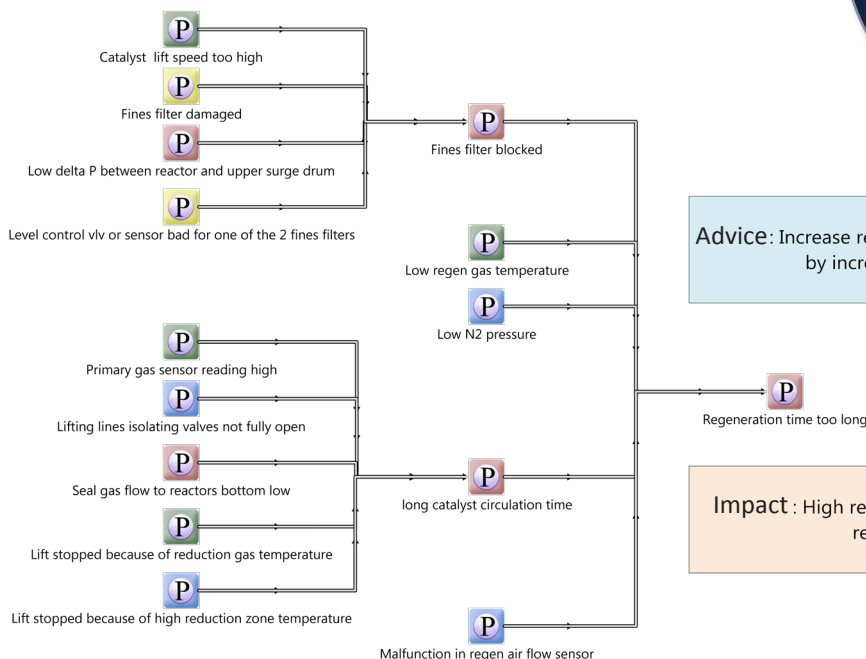

KRCA empowers operators to quickly diagnose the root cause of issues in real time and take immediate action based on best practices and operational knowledge, reducing the time needed for diagnosis and decision-making and optimizing your operations.

**Advice:** Increase recycle gas mole ratio (H<sub>2</sub>/feed ratio) by increasing compressor RPM.

**Impact:** High regeneration time affects reforming reactor performance

KRCA Example: Catalyst Regeneration Fault Propagation Model



# KWorkflow: Best Practices Online

KWorkflow is a flexible workflow management solution which offers a range of capabilities for various users, such as:

## Application Developers

Graphically design static and generic workflows using sequential and parallel activities. These activities can interact with more than one application, synchronizing data, execution, or interaction flow between them. Workflows can be triggered automatically by events detected by the KRules and/or KRCA modules, or manually by the end-users.

## Supervisors

Monitor activities in real time using the graphical environment, KNet Desktop.

## End-Users

Easily handle and interact with workflows and follow-up actions.

Designed workflows can help you implement and execute:

- Corrective actions
- Start-up and shut down procedures
- Resolution of repeated problems
- Recovery procedures
- Escalation of responses to incidents, and much more...

## KWorkflow Goals

- 1 Schedule and automate work activities
- 2 Institutionalizes and enforces best practices
- 3 Synchronize and federate MES applications through events and activities
- 4 Reduce resolution time and prevent decision bottlenecks
- 5 Coordinate efforts among multiple teams and departments, defining stakeholders and easily shifting people to new roles

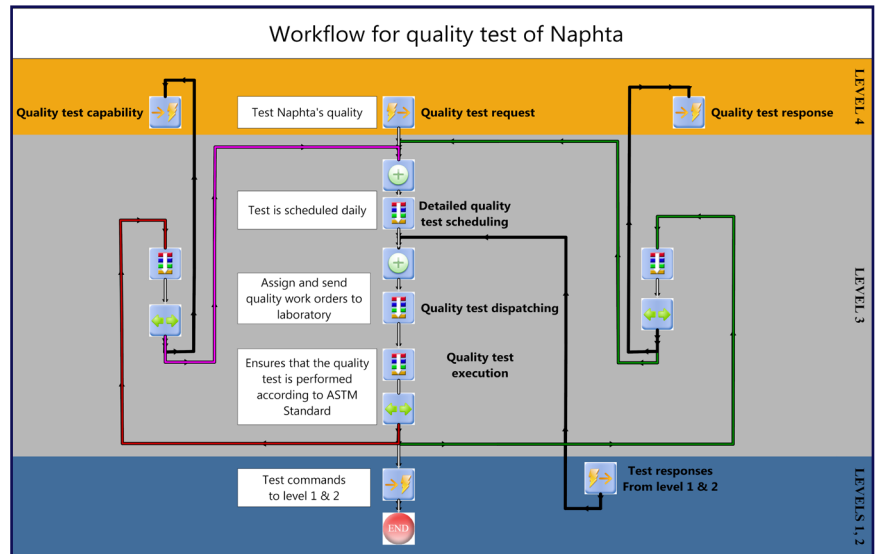

KWorkflow Example: Test Procedure

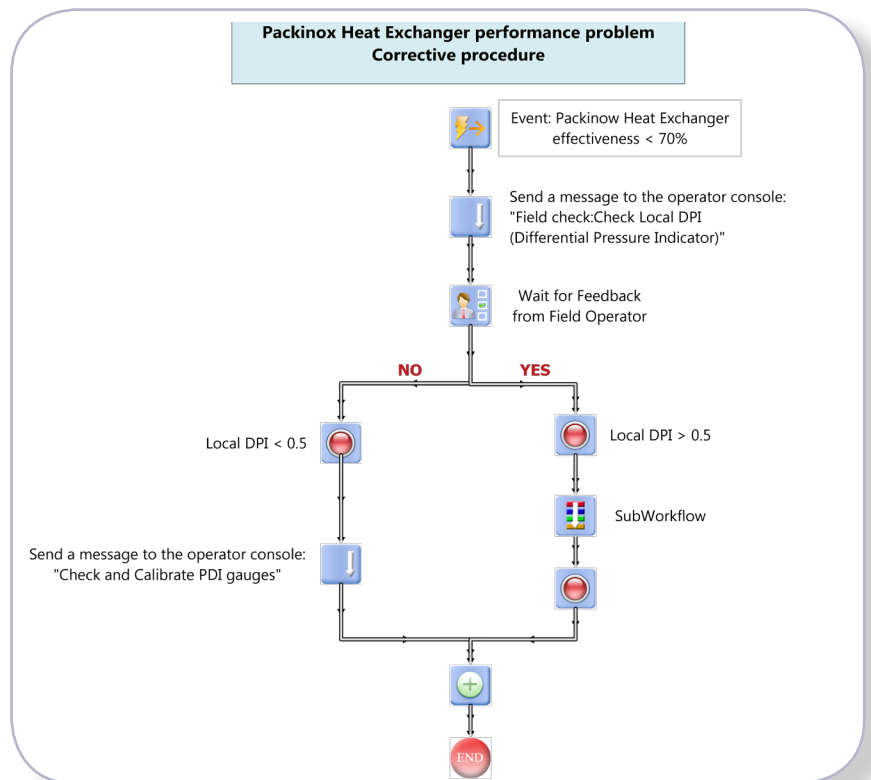

KWorkflow Example: Corrective Procedure

KWorkflow allows users - from those on the plant floor to senior plant and operations managers and executives - to take the best course of action based on knowledge that has been accumulated in the system. It enables users to synchronize applications found across multiple levels of the enterprise.

# KMap: Plant & Process Visualization

KMap module is designed to allow application engineers to represent plant objects, piping, and unit hierarchy, as well as build several types of HMI graphics such as plant and unit overview graphics, process operational graphics, and process flow diagrams.

To do so, the graphical development environment offers you a wide range of features and tools including:

- Microsoft® Office look, feel and navigation
- Predefined and customizable toolboxes of plant and process objects to drag, drop and connect from
- Association of the right data collected from levels two, three and four to your plant and process objects
- Definition of relations between your domain objects, such as connection and containment relations

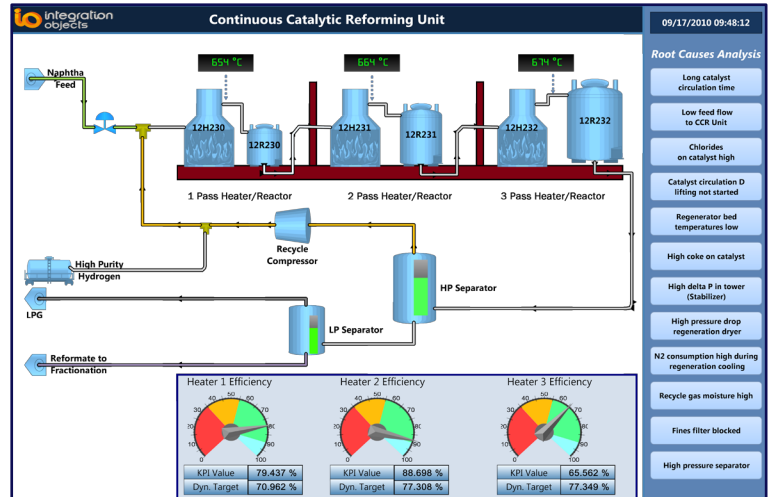

## KMap Goals

- 1 Facilitate access to different levels of information
- 2 Increase operational visibility
- 3 Link your plant representation to detected events and abnormal conditions
- 4 Develop logic based on the defined relations between your plant and process objects

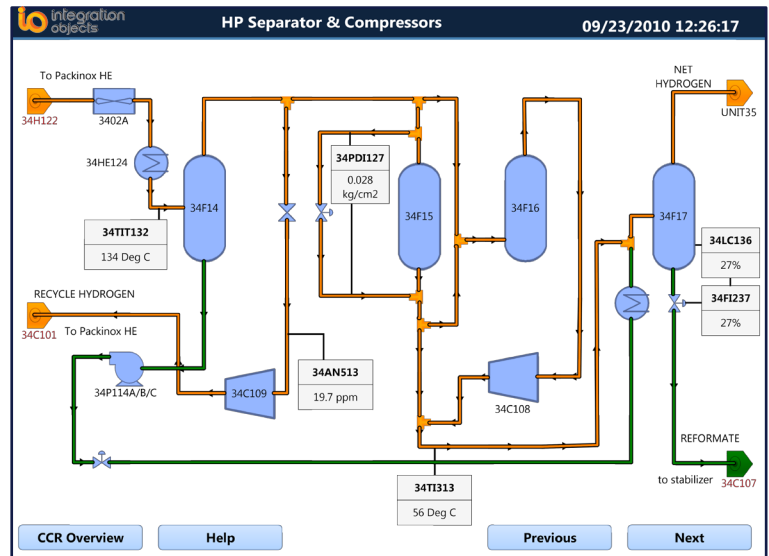

KMap Example: Process Flow Diagram

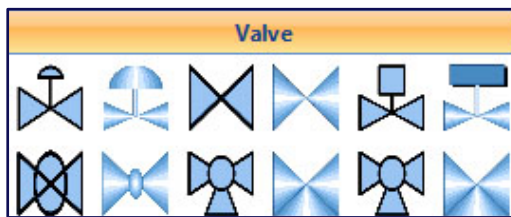
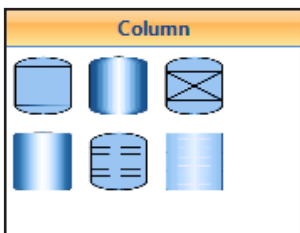

KMap Toolbox examples

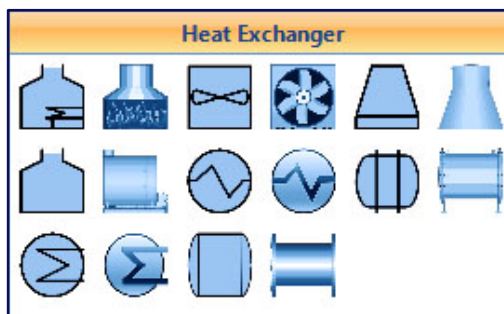
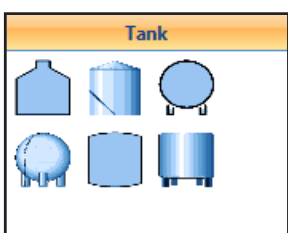

KMap enables users to see the plant's status in real time, enabling users to supervise deviations from operational objectives before they disrupt production.

# Architecture

Acting as an intelligent integration platform, including an Enterprise Service Bus, KNet synchronizes systems and applications from different levels of the industrial network thanks to its three-tier client/server architecture:

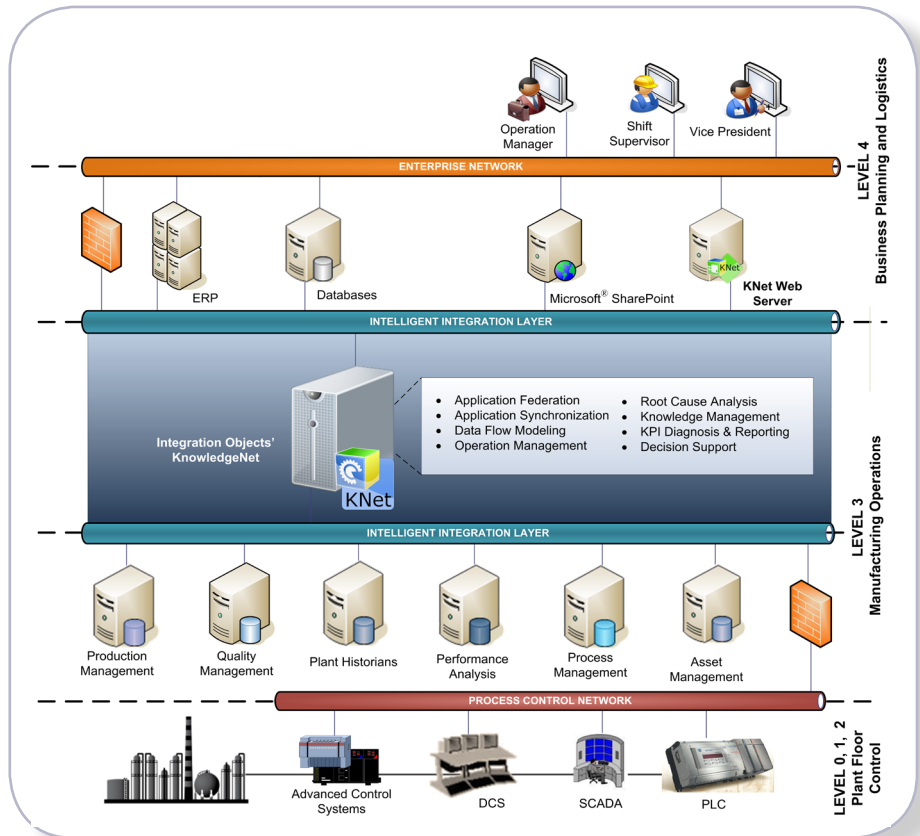

KNet Architecture: Intelligent and Extensible Integration Platform

## Data Sources

Data sources can be located in levels two, three, and four. Any system in your industrial network can act as a data source for the KNet Platform. Using standards such as OPC, ADO .NET, Web Services, and SOA (Service Oriented Architecture), KNet can integrate any data source part of the process control network or the enterprise network such as MES and ERP applications.

## Clients

KNet Platform includes a generic KNet client called KNet Desktop, usually located in levels three and four, that allows end-users to develop applications based on four different modules: KMap, KWorkflow, KRules, and KRCA (KNet Root Cause Analysis). Application developers can also build thick and web-based KNet Clients using different APIs and SDKs provided.

## Servers

KNet Server and KNet Engine include core and user-defined components. These servers are usually located between levels; however, depending on your application and its objective, you can easily deploy them in any level of your plant network that you see fit.

## Who benefits from KNet?

Oil & Gas	Power Plants
Water & Utilities	Chemicals
Oil Refineries	Mining & Minerals

...and many more!



Integration Objects is a world-leading systems integrator and solutions provider specializing in real-time data collection, preventative detection of abnormal conditions, and automated root cause analysis. We support our customers in optimizing their business and manufacturing processes, thereby maximizing plant safety, increasing asset availability, and facilitating better resolution decision-making. Our industry insight and wide range of experience in over 30 countries means Integration Objects' team of engineers and domain experts is always ready to help you in creating integral links between your business and operational objectives and reaching operations excellence.

For more information about KnowledgeNet, Integration Objects, and our solutions, please visit our website at [www.integrationobjects.com](http://www.integrationobjects.com).

**Tunis, Tunisia:** +216 71 195 360

**Genova, Italy:** +39 010 911 3076

**Houston, USA:** +1 713 609 9208

**Online:** [www.integrationobjects.com](http://www.integrationobjects.com)

**Sales:** [sales@integrationobjects.com](mailto:sales@integrationobjects.com)

**Support:** [customerservice@integrationobjects.com](mailto:customerservice@integrationobjects.com)